

MITSUBISHI GENERAL USE THYRISTORS

FT1500AU-240

HIGH VOLTAGE, HIGH POWER, GENERAL USE
DYNAMIC GATE, PRESS PACK TYPE

FT1500AU-240



- $I_T(AV)$ Average on-state current 1500A
- V_{DRM} Repetitive peak off state voltage 12000V
- Press pack type

OUTLINE DRAWING

Dimension in mm

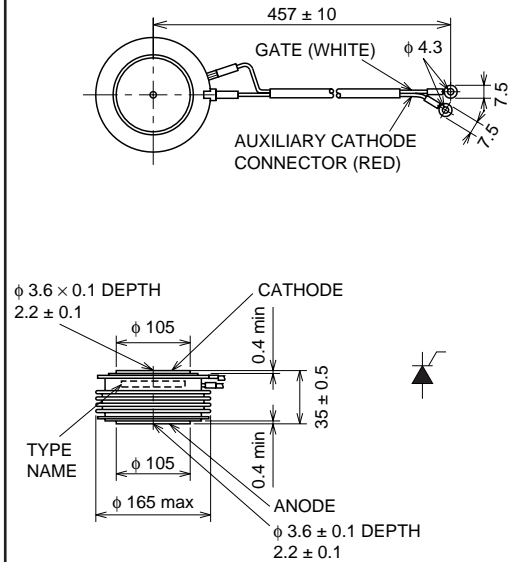

APPLICATION

AC switch for high voltage line, SVC

ABSOLUTE MAXIMUM RATINGS

Symbol	Parameter	Voltage class		Unit
		240		
VRRM	Repetitive peak reverse voltage	12000		V
VRSM	Non-repetitive peak reverse voltage	12000		V
VR(DC)	DC reverse voltage	9600		V
VDRM	Repetitive peak off-state voltage	12000		V
VDSM	Non-repetitive peak off-state voltage	12000		V
VD(DC)	DC off-state voltage	9600		V

Symbol	Parameter	Conditions	Ratings	Unit
$I_T(RMS)$	RMS on-state current		2360	A
$I_T(AV)$	Average on-state current	$f = 60\text{Hz}$, sine wave $\theta = 180^\circ$, $T_f = 88^\circ\text{C}$	1500	A
I_{TSM1}	Surge on-state current	One half cycle at 60Hz	34	kA
I_{TSM2}	Surge on-state current 2	One half cycle ($t_w = 12\text{ms}$), $T_j = 125^\circ\text{C}$ start $V_{FP} = 6\text{kV}$, $V_{RP} = 6\text{kV}$	28	kA
I^2t	Current-squared, time integration	One cycle at 60Hz	4.8×10^6	A^2s
di/dt	Critical rate of rise of on-state current	$V_D = 1/2V_{DRM}$, $I_G = 2.0\text{A}$, $di_G/dt = 1.5\text{A}/\mu\text{s}$, $T_j = 125^\circ\text{C}$	100	$\text{A}/\mu\text{s}$
PFGM	Peak forward gate power dissipation		30	W
PFG(AV)	Average forward gate power dissipation		8.0	W
VFGM	Peak forward gate voltage		20	V
VRGM	Peak reverse gate voltage		10	V
IFGM	Peak forward gate current		6.0	A
T_j	Junction temperature		$-40 \sim +125$	$^\circ\text{C}$
T_{stg}	Storage temperature		$-40 \sim +150$	$^\circ\text{C}$
—	Mounting force required	Recommended value 118	$108 \sim 132$	kN
—	Weight	Standard value	4000	g

Feb.1999

FT1500AU-240

HIGH VOLTAGE, HIGH POWER, GENERAL USE
DYNAMIC GATE, PRESS PACK TYPE

ELECTRICAL CHARACTERISTICS

Symbol	Parameter	Test conditions	Limits			Unit
			Min	Typ	Max	
I _{RRM}	Repetitive peak reverse current	T _j = 125°C, V _{RRM} Applied	—	—	1200	mA
I _{DRM}	Repetitive peak off-state current	T _j = 125°C, V _{DRM} Applied	—	—	1200	mA
V _{TM}	On-state voltage	T _j = 125°C, I _{TM} = 3000A, Instantaneous measurement	—	—	4.0	V
dv/dt	Critical rate of rise of off-state voltage	T _j = 125°C, V _D = 1/2V _{DRM}	2000	—	—	V/μs
V _{GT}	Gate trigger voltage	T _j = 25°C, V _D = 6V, R _L = 2Ω	—	—	2.5	V
V _{GD}	Gate non-trigger voltage	T _j = 125°C, V _D = 1/2V _{DRM}	0.2	—	—	V
I _{GT}	Gate trigger current	T _j = 25°C, V _D = 6V, R _L = 2Ω	—	—	350	mA
R _{th(j-f)}	Thermal resistance	Junction to fin	—	—	0.005	°C/W

PERFORMANCE CURVES

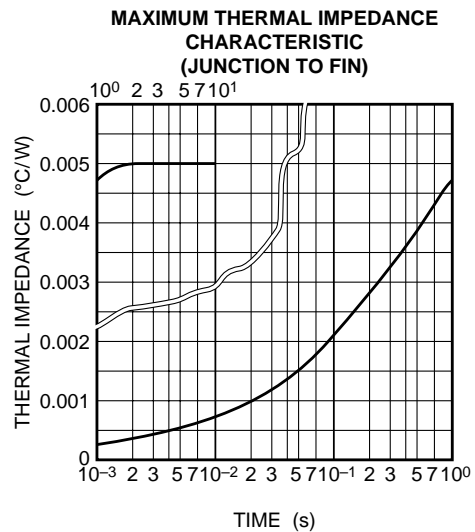
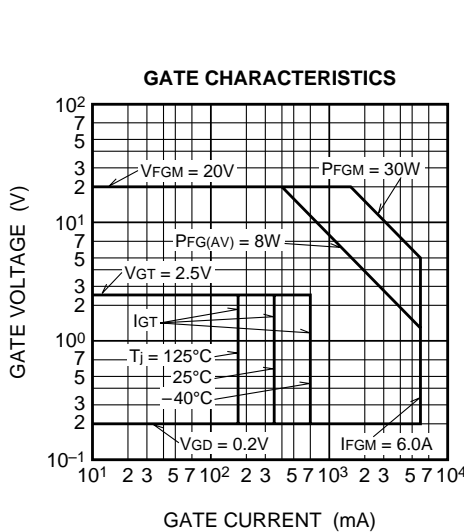
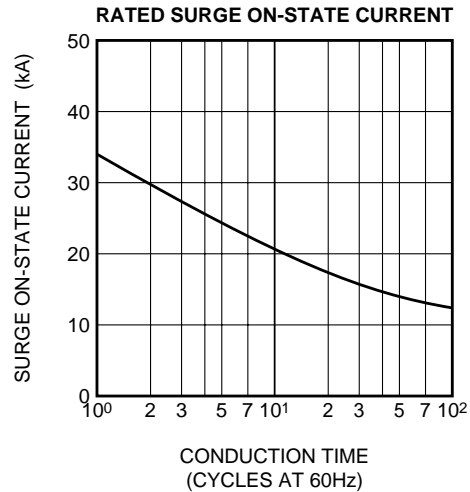
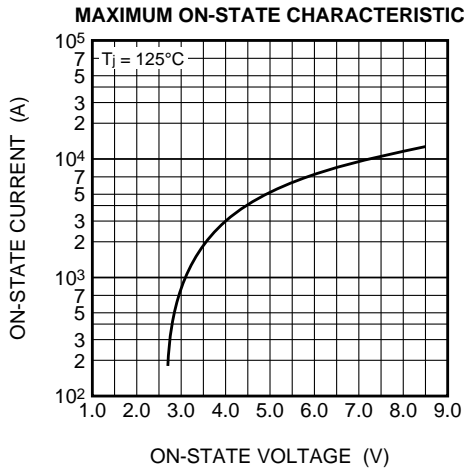

FT1500AU-240

**HIGH VOLTAGE, HIGH POWER, GENERAL USE
DYNAMIC GATE, PRESS PACK TYPE**

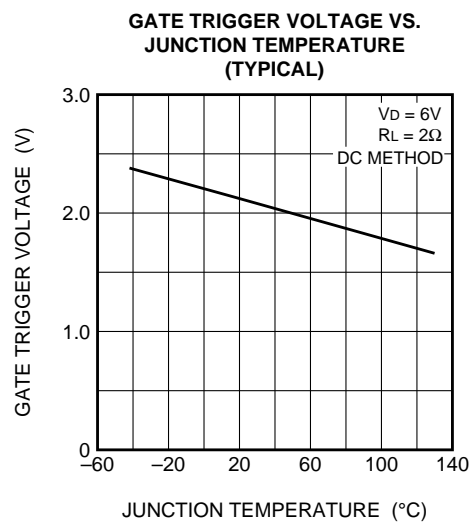
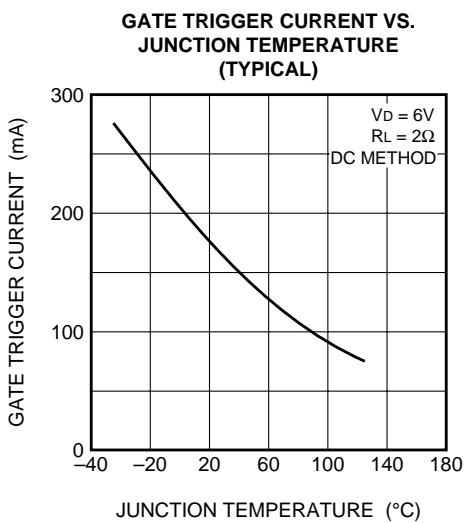
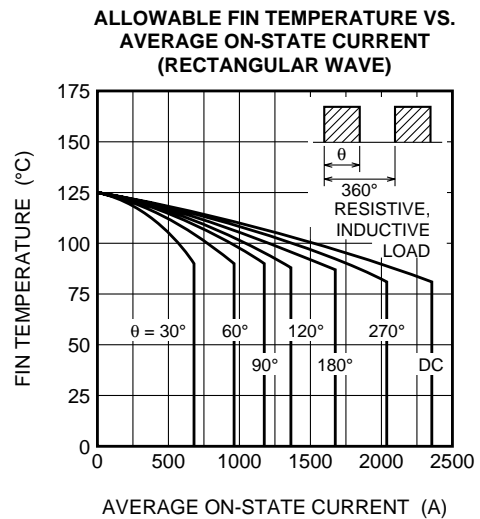
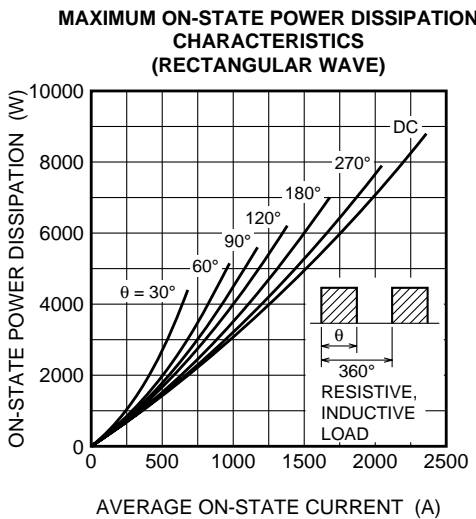
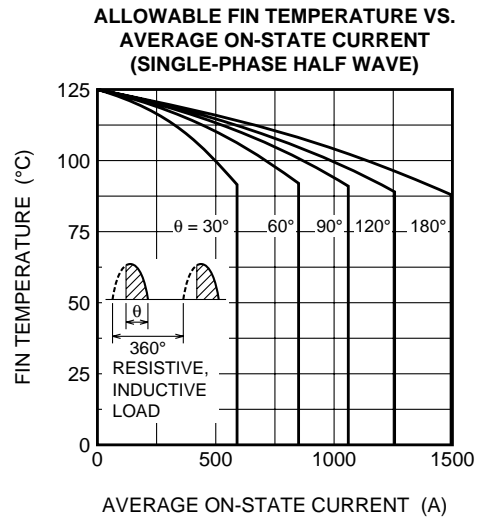
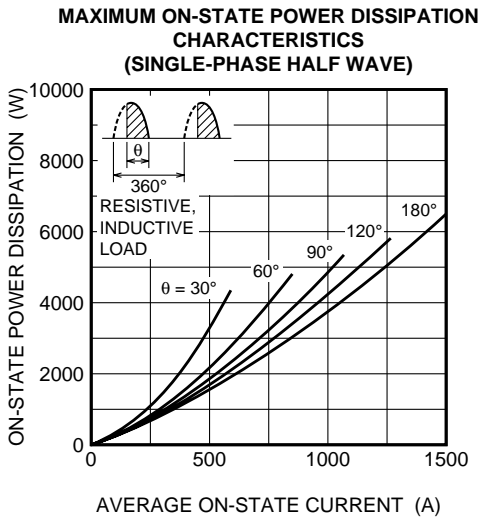

FT1500AU-240

HIGH VOLTAGE, HIGH POWER, GENERAL USE
DYNAMIC GATE, PRESS PACK TYPE

HOLDING CURRENT LATCHING CURRENT VS. JUNCTION TEMPERATURE (TYPICAL)

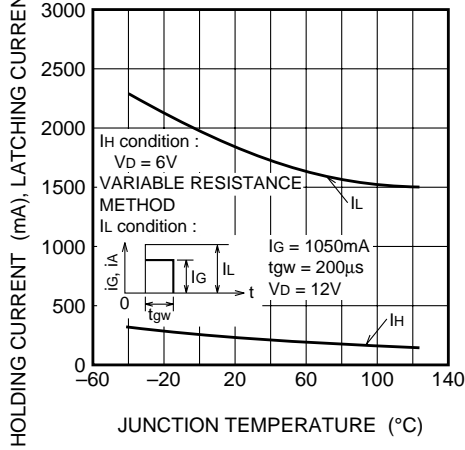

TURN-ON TIME VS. GATE CURRENT (TYPICAL)

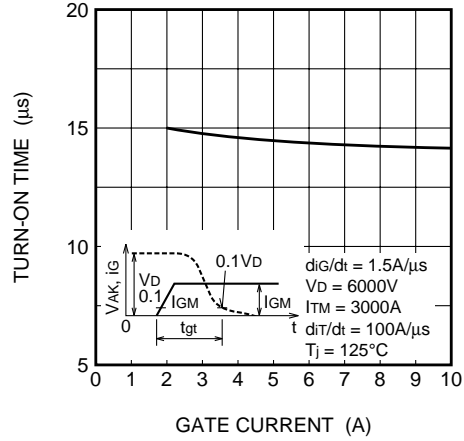

TURN-OFF TIME VS. JUNCTION TEMPERATURE (TYPICAL)

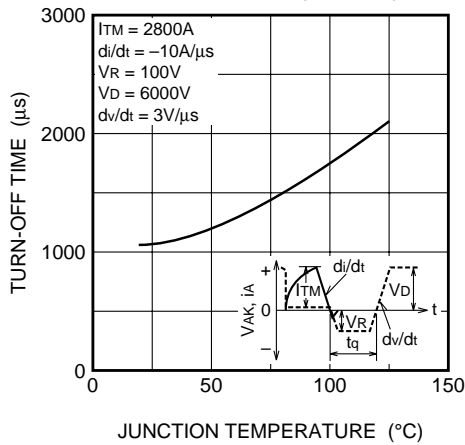

TURN-OFF TIME VS. RATE OF RISE OF OFF-STATE VOLTAGE (TYPICAL)

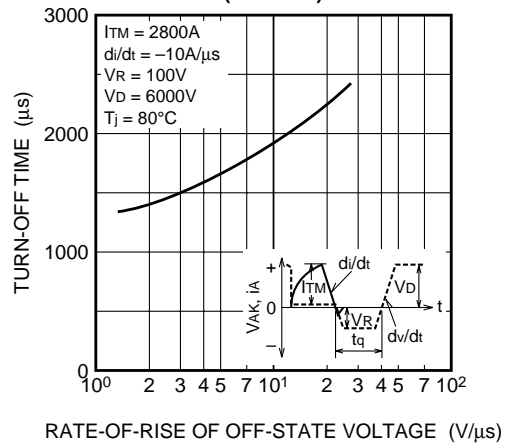

REVERSE RECOVERED CHARGE VS. JUNCTION TEMPERATURE (TYPICAL)

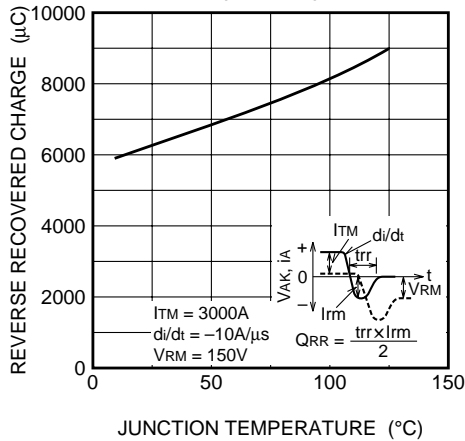

REVERSE RECOVERED CHARGE VS. RATE OF DECREASE OF ON-STATE CURRENT (TYPICAL)

